



HANDELS-, INDUSTRIE-,  
HANDWERKS- UND LAND-  
WIRTSCHAFTSKAMMER BOZEN

CAMERA DI COMMERCIO,  
INDUSTRIA, ARTIGIANATO  
E AGRICOLTURA DI BOLZANO

PARTNER DER WIRTSCHAFT

AL SERVIZIO DELL'ECONOMIA

# Der Eichdienst

## Von der Waage bis zum Taxameter

Insp. Stefano Delussu – 18. Dezember 2015



# Unsere Aufgabenbereiche sind:

- Anwendung der Normen der legalen Metrologie
- Eichung und Überwachung von Meßgeräten
- Kontrolle der Fertigpackungen
- Kontrolle der Gegenstände aus Edelmetallen



# Fundament der legalen Metrologie

- Legale Maßeinheiten
- Bezugsnormale
- Gesetze und Normen



# Die legalen Maßeinheiten

... sind die Grundlage der legalen Metrologie und der verschiedensten Handelstransaktionen.

Ohne sie wäre eine einheitliche Bestimmung der Menge, z.B. in Gramm, Meter, Watt, Liter, Bar und so weiter nicht möglich.

Weltweit wird heute das SI – Einheitensystem angewandt.

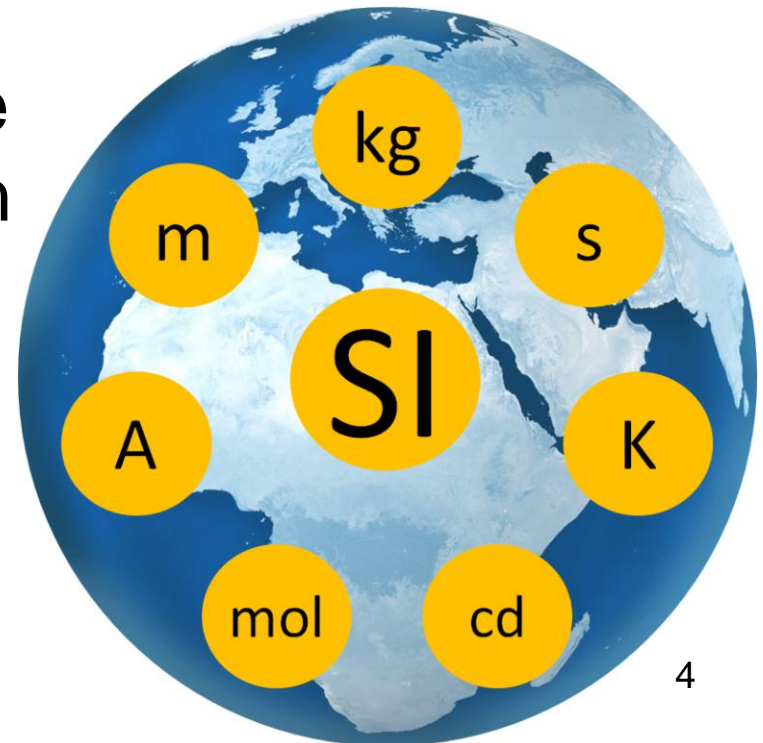



# Die Bezugsnormale

Um „einheitliche“ Maßeinheiten zu garantieren, braucht es dazu die jeweiligen Bezugsnormale

Die Definition erfolgt entweder in Form eines Gegenstandes (Urkilogramm)

oder

einer physikalischen Formel



HANDELS-, INDUSTRIE-,  
HANDWERKS- UND LAND-  
WIRTSCHAFTSKAMMER BOZEN

CAMERA DI COMMERCIO,  
INDUSTRIA, ARTIGIANATO  
E AGRICOLTURA DI BOLZANO

PARTNER DER WIRTSCHAFT

AL SERVIZIO DELL'ECONOMIA

# UR-Meter und UR-Kilogramm

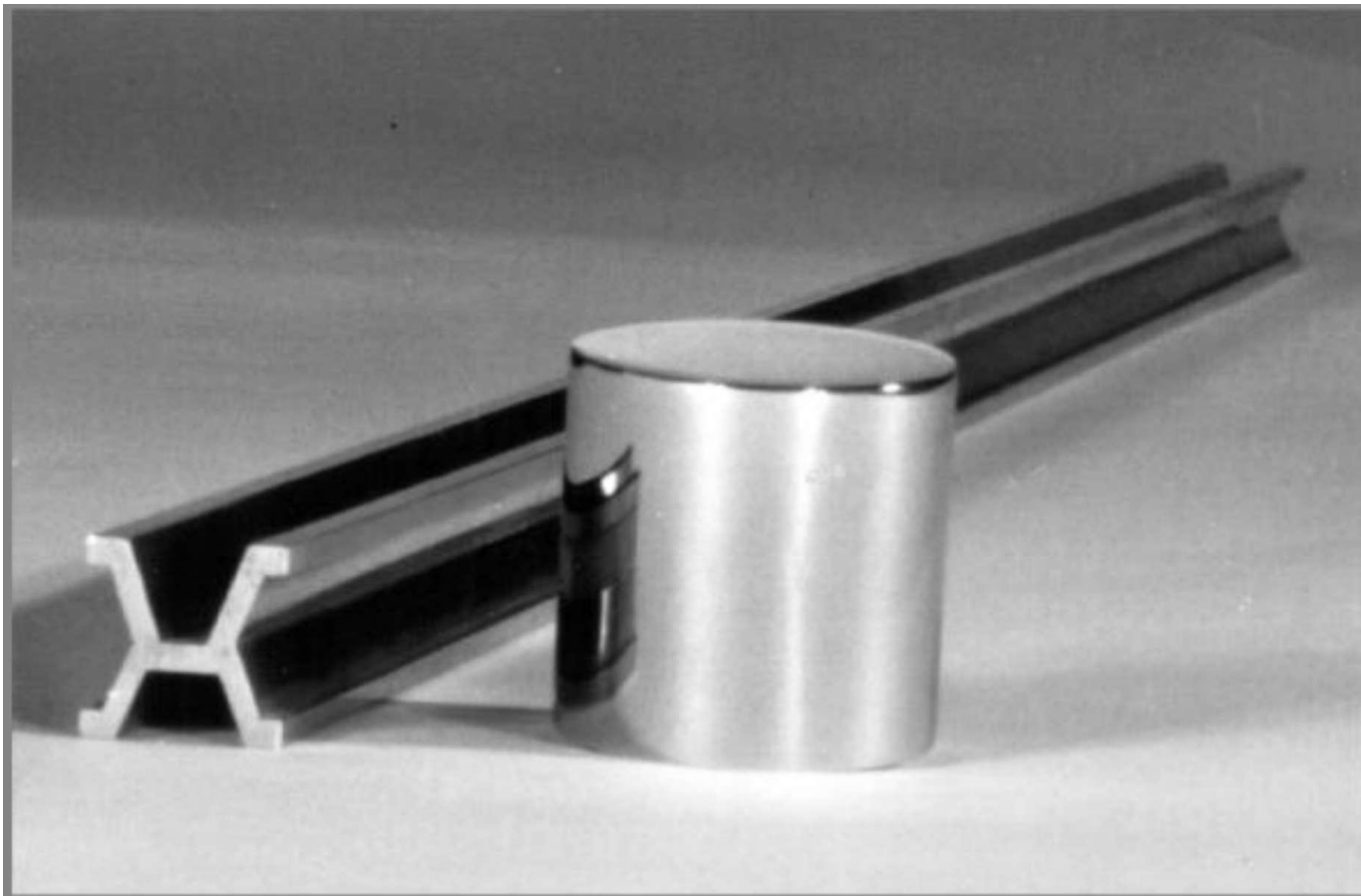



# Das UR-Meter

1791:

Das neue, noch nicht „Meter“ genannte Längenmaß war der zehnmillionste Teil des Erdmeridianquadranten (Strecke vom Pol zum Äquator).



Seit 1983:

1 Meter ist jene Strecke, die das Licht im Vakuum in  $1 / 299.792.458$  Sekunden zurücklegt.



# Die Zeit

Eine Sekunde ist das  
9 192 631 770 fache der  
Periodendauer der dem  
Übergang zwischen den beiden  
Hyperfeinstrukturniveaus des  
Grundzustandes von Atomen  
des Nuklids  $^{133}\text{Cs}$   
entsprechenden Strahlung.







# Das UR-Kilogramm

Seit 1889 bildet das Urkilogramm den weltweit einzigartigen Referenzwert für die Maßeinheit Kilogramm.

Es wird in einem Tresor des Internationalen Büros für Maß und Gewicht (BIPM) in Sèvres bei Paris aufbewahrt.

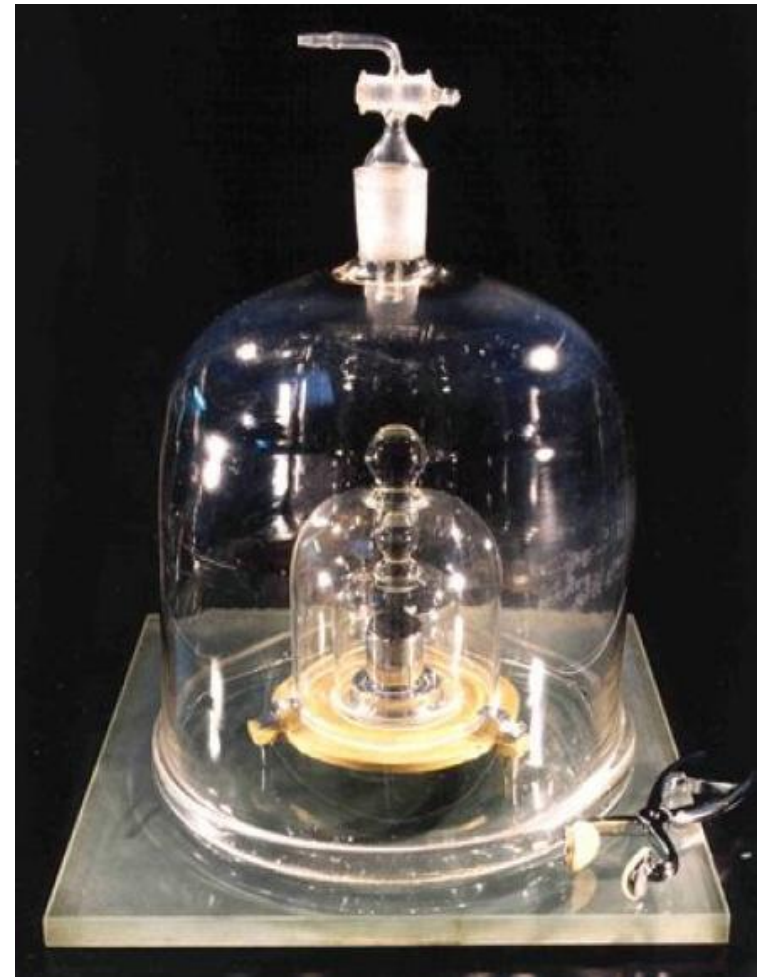



# Was bedeutet eichen?

Der Begriff "Eichen" wird im Sprachgebrauch mit unterschiedlicher Bedeutung verwendet.

Genau genommen bedeutet er eine gesetzlich vorgeschriebene Prüfung von Messgeräten durch einen amtlichen Messdienst.

In Italien sind dies:

- die Hersteller
- die Eichämter der Handelskammern
- die privaten Eichstellen



# Die Eichung garantiert:

Den Bezug des  
Meßergebnisses  
des Messgerätes  
auf ein **Normal**

(beim Gewicht auf  
das Urkilogramm  
in Paris)

1 kg

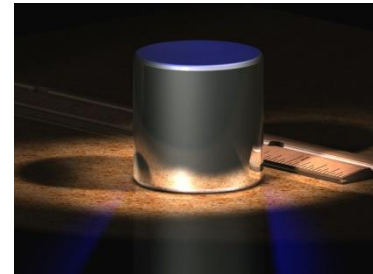

$$1 \text{ kg} + 0,52 \text{ mg U (k2)} = 0,50 \text{ mg}$$





# Die Eichung garantiert:

Die metrologische Qualität des Meßgerätes, weil die festgestellten metrologischen Eigenschaften für einen vorbestimmten Zeitraum beibehalten werden

Eichung OK  
bis 03 / 2017

PERIODISCHE ÜBERPRÜFUNG / FÄLLIGKEIT VERIFICA PERIODICA / SCADENZA		
Monat mese	JAHR ANNO	Monat mese
1	2017	7
2		8
3	EICHDienst HANDELSKAMMER BOZEN	9
4		10
5	SERVIZIO METRICO	11
6	C.C.I.A.A. BOLZANO	12

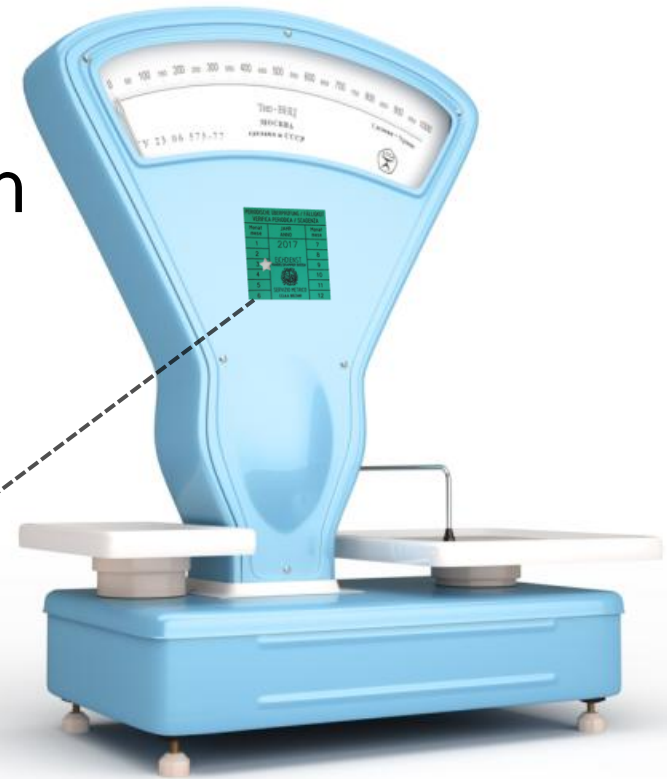



# Die Eichung garantiert:

Die Sicherheit vor Manipulation der metrologischen Eigenschaften des Meßgerätes durch Eichsiegel



Nummer  
Eichdienst



Nummer  
Eichinspektor

Italienweit einzigartige Datenbank "CLEARCO,, mit über 6.000 Bauartzulassungen und Plombenplänen



HANDELS-, INDUSTRIE-,  
HANDWERKS- UND LAND-  
WIRTSCHAFTSKAMMER BOZEN

CAMERA DI COMMERCIO,  
INDUSTRIA, ARTIGIANATO  
E AGRICOLTURA DI BOLZANO

PARTNER DER WIRTSCHAFT

AL SERVIZIO DELL'ECONOMIA

# Die Eichung garantiert:

... in Summe die Rechtssicherheit der Messung.



# Welche Arten von Eichungen gibt es?

- \* Ersteichung oder Konformitätsbewertungsverfahren  
(vor der 1. Benutzung des Messgerätes)  
*=> der Hersteller ist Auftraggeber / Antragsteller*
- \* Periodische Eichungen (nach der Inbetriebnahme)  
*=> der Benutzer ist dafür verantwortlich*
- \* Amtliche Überwachungen (in service inspections)  
*=> unangekündigte Kontroll-Eichungen (Eichdienst)*



HANDELS-, INDUSTRIE-,  
HANDWERKS- UND LAND-  
WIRTSCHAFTSKAMMER BOZEN

CAMERA DI COMMERCIO,  
INDUSTRIA, ARTIGIANATO  
E AGRICOLTURA DI BOLZANO

PARTNER DER WIRTSCHAFT

AL SERVIZIO DELL'ECONOMIA

# Welche Messgeräte werden geeicht?



PERIODISCHE ÜBERPRÜFUNG / FÄLLIGKEIT VERIFICA PERIODICA / SCADENZA		
Monat mese	JAHR ANNO	Monat mese
1	2017	7
2	EICHDIENST HANDELSKAMMER BOZEN 	8
3		9
4		10
5		11
6		12
SERVIZIO METRICO CCIAA BOLZANO		







HANDELS-, INDUSTRIE-,  
HANDWERKS- UND LAND-  
WIRTSCHAFTSKAMMER BOZEN

CAMERA DI COMMERCIO,  
INDUSTRIA, ARTIGIANATO  
E AGRICOLTURA DI BOLZANO

PARTNER DER WIRTSCHAFT

AL SERVIZIO DELL'ECONOMIA

# MID – metrologische Aufschriften

**C** **E** **M 08** **0445**



HANDELS-, INDUSTRIE-,  
HANDWERKS- UND LAND-  
WIRTSCHAFTSKAMMER BOZEN

CAMERA DI COMMERCIO,  
INDUSTRIA, ARTIGIANATO  
E AGRICOLTURA DI BOLZANO

PARTNER DER WIRTSCHAFT

AL SERVIZIO DELL'ECONOMIA

# MID – Wasserzähler M001



CE M 08 0445





HANDELS-, INDUSTRIE-,  
HANDWERKS- UND LAND-  
WIRTSCHAFTSKAMMER BOZEN

CAMERA DI COMMERCIO,  
INDUSTRIA, ARTIGIANATO  
E AGRICOLTURA DI BOLZANO

PARTNER DER WIRTSCHAFT

AL SERVIZIO DELL'ECONOMIA

# MID – Gaszähler M002

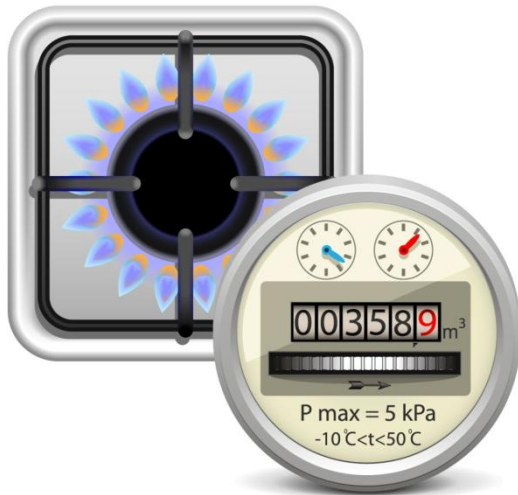

CE M 08 0445





# MID – Stromzähler M003



NEU - Geeicht



ALT - nicht geeicht

CE M 08 0445



HANDELS-, INDUSTRIE-,  
HANDWERKS- UND LAND-  
WIRTSCHAFTSKAMMER BOZEN

CAMERA DI COMMERCIO,  
INDUSTRIA, ARTIGIANATO  
E AGRICOLTURA DI BOLZANO

PARTNER DER WIRTSCHAFT

AL SERVIZIO DELL'ECONOMIA

# MID – Wärmemengenzähler M004



CE M 08 0445





HANDELS-, INDUSTRIE-,  
HANDWERKS- UND LAND-  
WIRTSCHAFTSKAMMER BOZEN

CAMERA DI COMMERCIO,  
INDUSTRIA, ARTIGIANATO  
E AGRICOLTURA DI BOLZANO

PARTNER DER WIRTSCHAFT

AL SERVIZIO DELL'ECONOMIA

# MID – Messanlagen kontinuierliche und dynamische Messung von Flüssigkeiten außer Wasser M005



CE M 08 0445



HANDELS-, INDUSTRIE-,  
HANDWERKS- UND LAND-  
WIRTSCHAFTSKAMMER BOZENO

CAMERA DI COMMERCIO,  
INDUSTRIA, ARTIGIANATO  
E AGRICOLTURA DI BOLZANO

PARTNER DER WIRTSCHAFT

AL SERVIZIO DELL'ECONOMIA

# Tankstellen





HANDELS-, INDUSTRIE-,  
HANDWERKS- UND LAND-  
WIRTSCHAFTSKAMMER BOZEN

CAMERA DI COMMERCIO,  
INDUSTRIA, ARTIGIANATO  
E AGRICOLTURA DI BOLZANO

PARTNER DER WIRTSCHAFT

AL SERVIZIO DELL'ECONOMIA

# Eichung einer Tankstelle







HANDELS-, INDUSTRIE-,  
HANDWERKS- UND LAND-  
WIRTSCHAFTSKAMMER BOZEN

CAMERA DI COMMERCIO,  
INDUSTRIA, ARTIGIANATO  
E AGRICOLTURA DI BOLZANO

PARTNER DER WIRTSCHAFT

AL SERVIZIO DELL'ECONOMIA

# MID – selbsttätige Waagen M006

CE M 08 0445





HANDELS-, INDUSTRIE-,  
HANDWERKS- UND LAND-  
WIRTSCHAFTSKAMMER BOZEN

CAMERA DI COMMERCIO,  
INDUSTRIA, ARTIGIANATO  
E AGRICOLTURA DI BOLZANO

PARTNER DER WIRTSCHAFT

AL SERVIZIO DELL'ECONOMIA

# MID – Taxameter M007

CE M 08 0445





HANDELS-, INDUSTRIE-,  
HANDWERKS- UND LAND-  
WIRTSCHAFTSKAMMER BOZEN

CAMERA DI COMMERCIO,  
INDUSTRIA, ARTIGIANATO  
E AGRICOLTURA DI BOLZANO

PARTNER DER WIRTSCHAFT

AL SERVIZIO DELL'ECONOMIA

## MID – Maßverkörperungen M008

CE M 08 0445





# MID – Geräte zur Messung von Längen und ihrer Kombinationen M009

CE M 08 0445





HANDELS-, INDUSTRIE-,  
HANDWERKS- UND LAND-  
WIRTSCHAFTSKAMMER BOZEN

CAMERA DI COMMERCIO,  
INDUSTRIA, ARTIGIANATO  
E AGRICOLTURA DI BOLZANO

PARTNER DER WIRTSCHAFT

AL SERVIZIO DELL'ECONOMIA

# Meterware



Soluzione 1 "Pizza al Mentro"





# Messanlage für Baumstämme

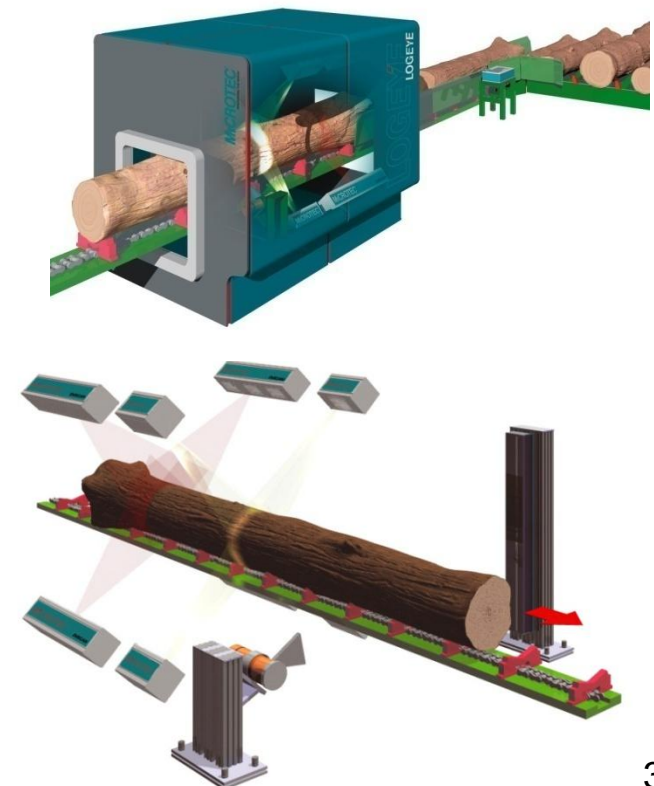



HANDELS-, INDUSTRIE-,  
HANDWERKS- UND LAND-  
WIRTSCHAFTSKAMMER BOZEN

CAMERA DI COMMERCIO,  
INDUSTRIA, ARTIGIANATO  
E AGRICOLTURA DI BOLZANO

PARTNER DER WIRTSCHAFT

AL SERVIZIO DELL'ECONOMIA

# MID – Abgasanalysatoren M010

CE M 08 0445





# Technische Zentren für Fahrtenstreiber (LKW + Bus)

neues, digitales System

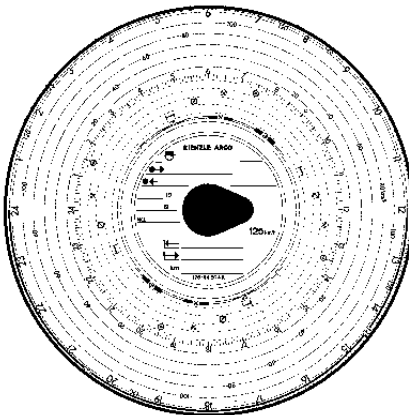

altes System







HANDELS-, INDUSTRIE-,  
HANDWERKS- UND LAND-  
WIRTSCHAFTSKAMMER BOZEN

CAMERA DI COMMERCIO,  
INDUSTRIA, ARTIGIANATO  
E AGRICOLTURA DI BOLZANO

PARTNER DER WIRTSCHAFT

AL SERVIZIO DELL'ECONOMIA

## Brückenwaage für LKWs





HANDELS-, INDUSTRIE-,  
HANDWERKS- UND LAND-  
WIRTSCHAFTSKAMMER BOZEN

CAMERA DI COMMERCIO,  
INDUSTRIA, ARTIGIANATO  
E AGRICOLTURA DI BOLZANO

PARTNER DER WIRTSCHAFT

AL SERVIZIO DELL'ECONOMIA

## Brückenwaage bei der Eichung





HANDELS-, INDUSTRIE-,  
HANDWERKS- UND LAND-  
WIRTSCHAFTSKAMMER BOZEN

CAMERA DI COMMERCIO,  
INDUSTRIA, ARTIGIANATO  
E AGRICOLTURA DI BOLZANO

PARTNER DER WIRTSCHAFT

AL SERVIZIO DELL'ECONOMIA

## Besondere Bauarten von Waagen





HANDELS-, INDUSTRIE-,  
HANDWERKS- UND LAND-  
WIRTSCHAFTSKAMMER BOZEN

CAMERA DI COMMERCIO,  
INDUSTRIA, ARTIGIANATO  
E AGRICOLTURA DI BOLZANO

PARTNER DER WIRTSCHAFT

AL SERVIZIO DELL'ECONOMIA

# Waagen im Betonwerk





HANDELS-, INDUSTRIE-,  
HANDWERKS- UND LAND-  
WIRTSCHAFTSKAMMER BOZEN

CAMERA DI COMMERCIO,  
INDUSTRIA, ARTIGIANATO  
E AGRICOLTURA DI BOLZANO

PARTNER DER WIRTSCHAFT

AL SERVIZIO DELL'ECONOMIA

... eine „alte“ Ladenwaage





HANDELS-, INDUSTRIE-,  
HANDWERKS- UND LAND-  
WIRTSCHAFTSKAMMER BOZEN

CAMERA DI COMMERCIO,  
INDUSTRIA, ARTIGIANATO  
E AGRICOLTURA DI BOLZANO

PARTNER DER WIRTSCHAFT

AL SERVIZIO DELL'ECONOMIA



... moderne,  
elektronische  
Ladenwaage

C € 08 0445 M



## Der Verkauf muss laut Nettogewicht erfolgen !

Wurst = **NETTO**



Papier (Verpackung) = **TARA**

Wurst + Papier = **BRUTTO**

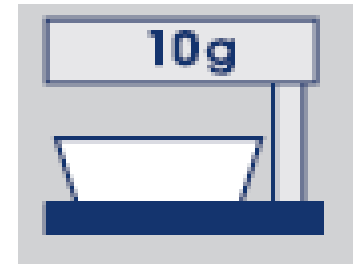



HANDELS-, INDUSTRIE-,  
HANDWERKS- UND LAND-  
WIRTSCHAFTSKAMMER BOZEN

CAMERA DI COMMERCIO,  
INDUSTRIA, ARTIGIANATO  
E AGRICOLTURA DI BOLZANO

PARTNER DER WIRTSCHAFT

AL SERVIZIO DELL'ECONOMIA

# Fertigpackungen mit ungleicher Füllmenge

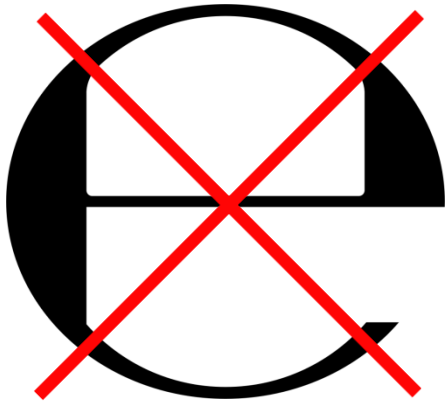





# Die Fertigpackungen mit gleicher Füllmenge





HANDELS-, INDUSTRIE-,  
HANDWERKS- UND LAND-  
WIRTSCHAFTSKAMMER BOZEN

CAMERA DI COMMERCIO,  
INDUSTRIA, ARTIGIANATO  
E AGRICOLTURA DI BOLZANO

PARTNER DER WIRTSCHAFT

AL SERVIZIO DELL'ECONOMIA

# Europäische Fertigpackungs-Richtlinie (e-Zeichen)

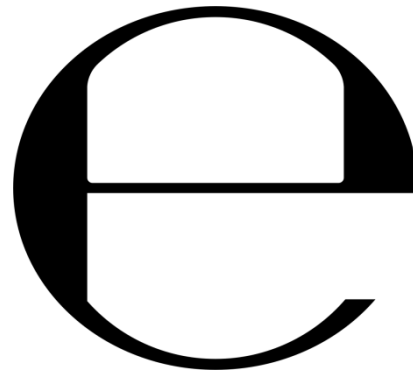



HANDELS-, INDUSTRIE-,  
HANDWERKS- UND LAND-  
WIRTSCHAFTSKAMMER BOZEN

CAMERA DI COMMERCIO,  
INDUSTRIA, ARTIGIANATO  
E AGRICOLTURA DI BOLZANO

PARTNER DER WIRTSCHAFT

AL SERVIZIO DELL'ECONOMIA

# Die Fertigpackungen – liberalisierte Nennfüllmengen





HANDELS-, INDUSTRIE-,  
HANDWERKS- UND LAND-  
WIRTSCHAFTSKAMMER BOZEN

CAMERA DI COMMERCIO,  
INDUSTRIA, ARTIGIANATO  
E AGRICOLTURA DI BOLZANO

PARTNER DER WIRTSCHAFT

AL SERVIZIO DELL'ECONOMIA

## Die Fertigpackungen – Angabe des Grundpreises



1,50 €

15,00 €/kg

1,20 €

12,00 €/kg





Der Eichdienst überwacht die korrekte Schreibweise der Maßeinheiten:

g	=	Gramm
kg	=	Kilogramm
L	=	Liter
l	=	Liter
ml	=	Milliliter

**Falsch:**

Kg. – KG. - KG - g. - Ml usw.





## Edelmetalle – Kontrolle des Feingehaltes *z.B. bei Schmuck aus Gold und Silber*

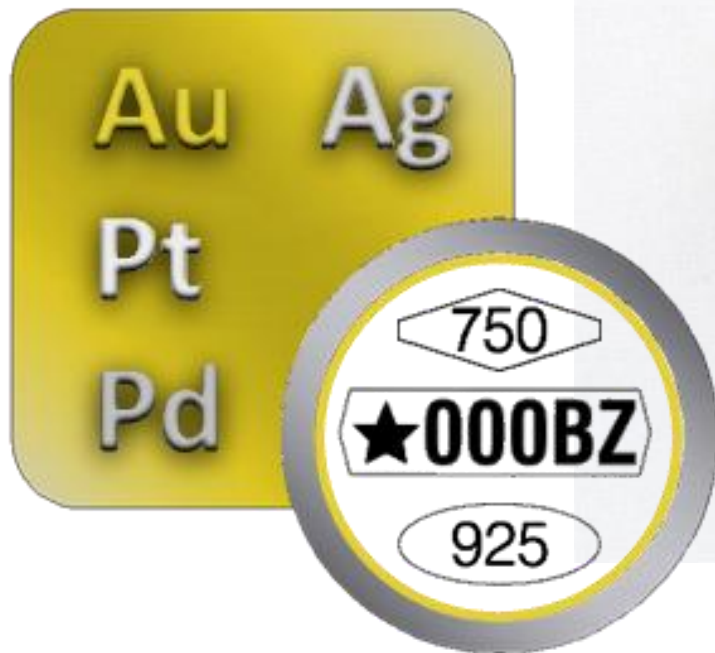



# Edelmetalle – Punzen für die Kennzeichnung des Feingehaltes

GOLD/ORO

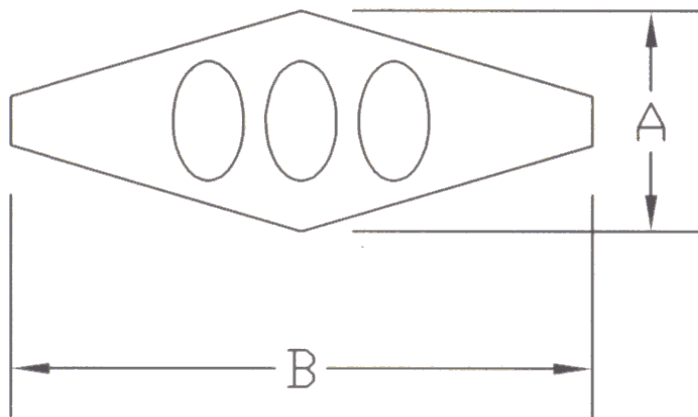

für die Titel 375-585-750 Tausendstel  
per i titoli di 375-585-750 millesimi

SILBER/ARGENTO

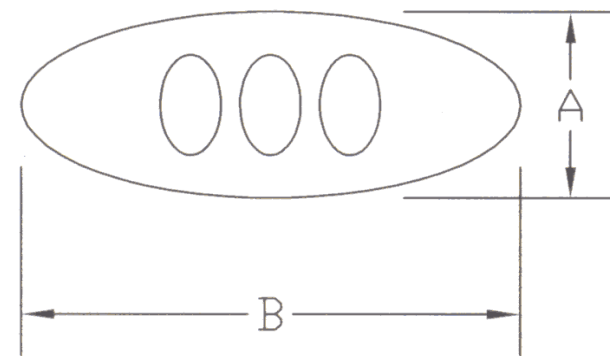

für alle Titel - per tutti i titoli



# Edelmetalle – Punzen für die Identifizierung des Herstellers

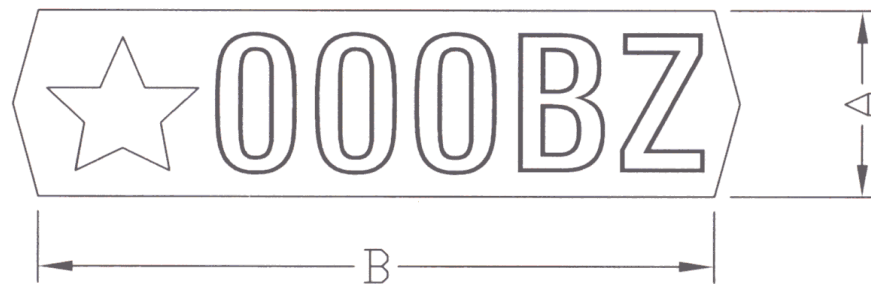
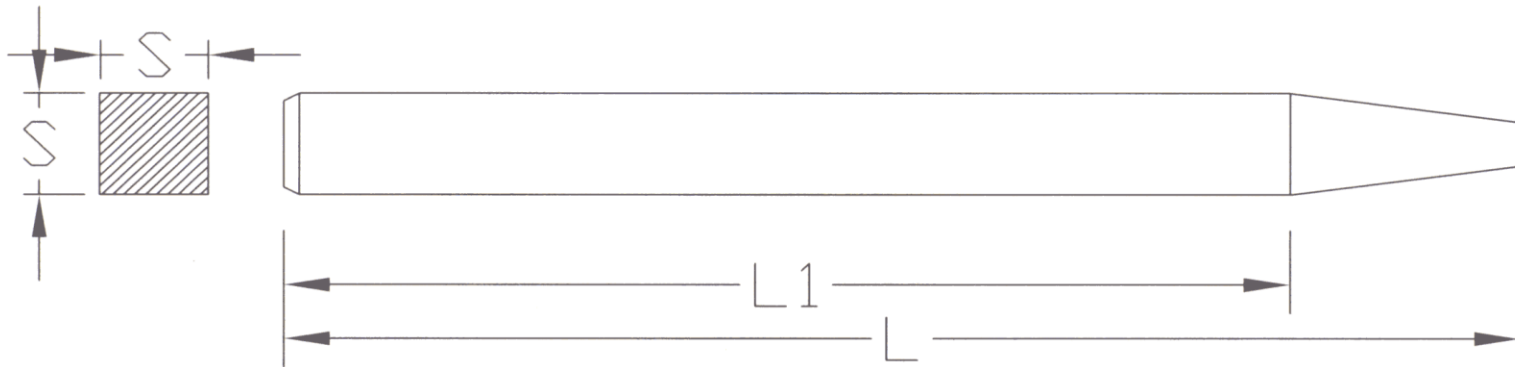





# Edelmetalle – Matrize und Punzen für die Identifizierung des Herstellers

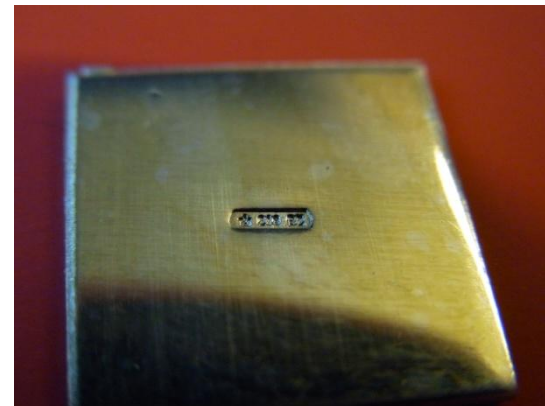



# Abdrücke der Punzen zur Kennzeichnung des Feingehalts (Gold) und der Identifikationsmarke





HANDELS-, INDUSTRIE-,  
HANDWERKS- UND LAND-  
WIRTSCHAFTSKAMMER BOZEN

CAMERA DI COMMERCIO,  
INDUSTRIA, ARTIGIANATO  
E AGRICOLTURA DI BOLZANO

PARTNER DER WIRTSCHAFT

AL SERVIZIO DELL'ECONOMIA

**Herzlichen Dank für Ihre  
Aufmerksamkeit!**